



# H2

## Video Wall Splicer

V1.3.1



## Specifications

## Change History

Document Version	Release Date	Description
V1.3.1	2021-01-08	Added one HDMI cable to the product accessories.
V1.3.0	2020-11-30	<ul style="list-style-type: none"> <li>Added the description for H_STD I/O card.</li> <li>Added the maximum layer quantity in the specification table.</li> <li>Changed the maximum widths and heights supported by the dual-link DVI and HDMI input and output connectors.</li> </ul>
V1.2.0	2020-09-04	Added the descriptions for the following cards: <ul style="list-style-type: none"> <li>H_2xDP1.1 input card</li> <li>H_20xRJ45 sending card</li> </ul>
V1.1.1	2020-08-20	Updated the maximum height supported by the H_16xRJ45+2xfiber sending card to 10240 pixels.
V1.1.0	2020-07-31	Added the descriptions for the following new functions: <ul style="list-style-type: none"> <li>Eye saver mode on Web page</li> <li>3D function</li> <li>Input source grouping</li> <li>App control on the pad device</li> </ul> Added the descriptions for the following input cards: <ul style="list-style-type: none"> <li>H_4x3G SDI input card</li> <li>H_2xCVBS+2xVGA input card</li> <li>H_4xVGA input card</li> </ul>
V1.0.1	2020-06-02	Updated the descriptions of the H_2xRJ45 IP input card.
V1.0.0	2020-05-15	First release

## Introduction

The H2 is Ovideon's newest generation of video wall splicer, featuring excellent image quality and designed especially for fine-pitch LED screens. The H2 can work as splicing processors that integrate both video processing and video control capabilities, or work as pure splicing processors. The whole unit adopts a modular and plug-in design, and allows for flexible configuration and hot swapping of input and output cards. Thanks to excellent features and stable performance, the H2 can be widely used in a variety of applications, such as energy and power, judicial departments and prisons, military command, water conservancy and hydrology, meteorologic earthquake prediction, enterprise management, metallurgy of steel, banking and finance, national defense, public security traffic management, exhibitions and presentations, production scheduling, radio and television, educational and scientific research, as well as stage rental applications.

Based on the powerful hardware FPGA system architecture, with a modular and plug-in design, the H2 features a stable and highly efficient pure hardware architecture, and provides a variety of connector modules for flexible and personalized configuration, allowing for easy maintenance and low failure rate. The H2 provides the industry-standard input connectors, including HDMI, DVI, DP, VGA, CVBS, SDI and IP, and supports 10-bit video source input and processing, as well as 4K high-definition inputs and outputs. The H2 also provides two kinds of LED 4K sending cards, allowing for the backup between the OPT ports and Ethernet ports as well as ultra-long distance transmission. Moreover, the H2 supports multi-screen and multi-layer management, input and output EDID management and monitoring, input source renaming, BKG and OSD settings and more, bringing you a rich image construction experience.

In addition, the H2 adopts the B/S architecture and supports cross-platform, cross-system access and control without the need to install an application program. On a Windows, Mac, iOS, Android or Linux platform, online collaboration of multiple users is supported and the Web page response speed is very fast, which greatly improves on-site setup efficiency. What's more, the H2 supports online firmware update, allowing for easy hardware update on a PC.

## Features

### Modular and plug-in design, for flexible configuration

- Two kinds of LED 4K sending cards
  - H\_20xRJ45 sending card loads up to 13,000,000 pixels.
  - H\_16xRJ45+2xfiber sending card loads up to 10,400,000 pixels and provides two OPT ports that copy the outputs on Ethernet ports.
- Multi-capacity configuration on a single card slot
  - 4x 2K×1K@60Hz
  - 2x 4K×1K@60Hz
  - 1x 4K×2K@60Hz
- Simple screen configuration using a single card and connector
- Online status monitoring of all input and output cards
- Hot-swappable input and output cards
- H\_2xRJ45 IP input card supports up to 100 IP camera inputs and input mosaic.
- Auto decryption of HDCP-encrypted sources

### Multi-screen management, for centralized control

- Each screen can have its own output resolution.
- Output mosaic
 

Adopts the frame synchronization technology, which ensures all the output connectors output the image synchronously, and the image is complete and played smoothly, without any stuck, frame loss, tearing or piecing.
- Irregular screen configuration
 

Supports irregular rectangle mosaic without any limitations.
- Input source grouping management
- Eye saver mode
 

Display the image in a warmer but less bright way to relieve eye strain.
- LCD bezel compensation

### Diverse display possibilities, for richer visual experience

- Multi-layer display
 

A single card supports 16x 2K layers, 8x DL layers or 4x 4K layers.

All layers support cross-connector output and the layer quantity is not reduced for cross-connector output.
- High-definition scrolling text
 

Customize the scrolling text content, such as slogans or notification messages, and set the text style, scrolling direction and speed.
- Up to 2,000 presets
 

Fade effect and seamless switching supported, less than 60ms preset switching duration
- Scheduled playback of preset playlist
 

Set whether to add the presets to playlist, which is ideal for monitoring, exhibitions, presentations, and other applications.
- OSD settings on a single screen and adjustable OSD transparency
- BKG settings
 

BKG images do not occupy the layer resources. The max. width and height of a BKG image is up to 15K and 8K respectively.
- Channel logo management
 

Set a text or image logo for identifying the input source.
- Input source cropping and renaming after cropping
 

Crop any input source image and form a new input source after cropping.
- HDR and 10-bit video processing, allowing for a more exquisite and clear image
- Color adjustment
 

Input, output and layer color adjustable, including the brightness, contrast, saturation, hue and Gamma
- 3D function
 

Work with Ovideon's 3D emitter – EMT200 to enjoy the 3D visual effect.

### Web-page control, easy, friendly and convenient

- Web control
 

Real-time response and 1000M/100M self-adaptive network control, allowing for multi-user collaboration
- Monitoring of inputs and outputs on Web page
- Firmware update on Web page
- Ark Visualized Management and Control Platform App control on pad device

## Status monitoring and redundant power supply, for better stability and reliability

- Self-test for fault detection
  - Auto monitoring and alarms
- Supports hardware monitoring, such as fan rotation speed, module temperature and voltage,
- running status, and sends fault alarms if necessary.
  - Supports an optional power supply for higher system reliability.

## Appearance

### Front Panel



\*The picture shown is for illustration purpose only. Actual product may vary due to product enhancement.

Name	Description
LCD screen	Displays the device status and monitoring information.

### Rear Panel

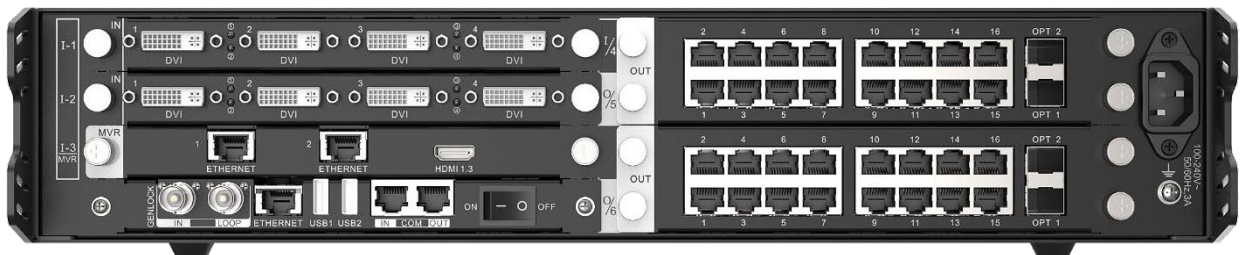

\*The picture shown is for illustration purpose only. Actual product may vary due to product enhancement.

#### Notes:

The silkscreen marking "I-x" or "I/x" indicates the slot is dedicated for the input card. "I" stands for input and "x" stands for the slot number. For example, "I-1" indicates this slot is the 1<sup>st</sup> input slot and for installing an input card only.

The silkscreen marking "O-x" or "O/x" indicates the slot is dedicated for the output card. "O" stands for output and "x" stands for the slot number. For example, "O-10" indicates this slot is the 10<sup>th</sup> output slot and for installing an output card only.

The silkscreen marking "I-x<sub>MVR</sub>" indicates the slot can accept an input card or preview card.

#### Input Card

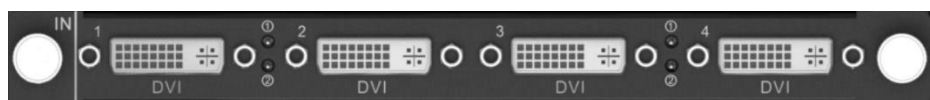

H\_4xDVI input card



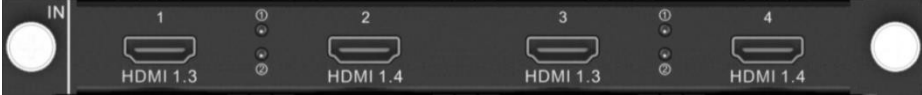

Support for single link and dual link input modes, and 10-bit input source  
HDCP 1.4 compliant

Does not support interlaced signal input.

	<ul style="list-style-type: none"> <li>● Single link mode: <ul style="list-style-type: none"> <li>– Four DVI connectors are all used for input.</li> <li>– Each connector supports the maximum resolution of 2048×1152@60Hz and the minimum resolution of 800×600@60Hz.</li> <li>– Custom resolutions: <ul style="list-style-type: none"> <li>Max. width: 2560 pixels (2560×972@60Hz)</li> <li>Max. height: 2560 pixels (884×2560@60Hz)</li> </ul> </li> </ul> </li> <li>● Dual link mode: <ul style="list-style-type: none"> <li>– Connectors 2 and 4 are used for input, and connectors 1 and 3 are unavailable.</li> <li>– Each connector supports the maximum resolution of 3840×1080@60Hz and the minimum resolution of 800×600@60Hz.</li> <li>– Custom resolutions: <ul style="list-style-type: none"> <li>Max. width: 4096 pixels (4096×1124@60Hz)</li> <li>Max. height: 4095 pixels (1014×4095@60Hz)</li> </ul> </li> </ul> </li> </ul> <p>Status LEDs:</p> <ul style="list-style-type: none"> <li>● On: The input source is accessed normally.</li> <li>● Off: No input source is accessed or the input source is abnormal.</li> </ul>
H_4xHDMI input card	 <p>Support for 10-bit input source Does not support interlaced signal input.</p> <p>Single link mode:</p> <ul style="list-style-type: none"> <li>● 2x HDMI 1.3 <ul style="list-style-type: none"> <li>– Each connector supports the maximum resolution of 2048×1152@60Hz, and the minimum resolution of 800×600@60Hz.</li> <li>– Custom resolutions: <ul style="list-style-type: none"> <li>Max. width: 2560 pixels (2560×972@60Hz)</li> <li>Max. height: 2560 pixels (884×2560@60Hz)</li> </ul> </li> <li>– HDCP 1.4 compliant</li> </ul> </li> <li>● 2x HDMI 1.4a <ul style="list-style-type: none"> <li>– Each connector supports the maximum resolution of 2048×1152@60Hz, and the minimum resolution of 800×600@60Hz.</li> <li>– Custom resolutions: <ul style="list-style-type: none"> <li>Max. width: 2560 pixels (2560×972@60Hz)</li> <li>Max. height: 2560 pixels (884×2560@60Hz)</li> </ul> </li> <li>– HDCP 1.4 compliant</li> </ul> </li> </ul> <p>Dual link mode:</p> <ul style="list-style-type: none"> <li>● Two HDMI 1.4a connectors are used for input, and two HDMI 1.3 connectors are unavailable.</li> <li>● Each connector supports the maximum resolution of 3840×1080@60Hz.</li> <li>● Custom resolutions: <ul style="list-style-type: none"> <li>Max. width: 4096 pixels (4096×1124@60Hz)</li> <li>Max. height: 4095 pixels (1014×4095@60Hz)</li> </ul> </li> <li>● HDCP 1.4 compliant</li> </ul> <p>Status LEDs:</p> <ul style="list-style-type: none"> <li>● On: The input source is accessed normally.</li> <li>● Off: No input source is accessed or the input source is abnormal.</li> </ul>

<p>H_1xHDMI2.0+1xDP1.2 input card</p>	 <p><b>Only one connector can be used each time.</b></p> <p>The default option is HDMI 2.0 connector.</p> <p>Does not support interlaced signal input.</p> <ul style="list-style-type: none"> <li>● 1x HDMI 2.0 <ul style="list-style-type: none"> <li>– Backward compatible with HDMI 1.4a and HDMI 1.3</li> <li>– Supports the maximum resolution of 4096×2160@60Hz or 8192×1080@60Hz (forced).</li> <li>– HDCP 2.2 compliant</li> <li>– Custom resolutions: <ul style="list-style-type: none"> <li>Max. width: 4092 pixels (4092 ×261@60Hz)</li> <li>Max. height: 4095 pixels (2188 ×095@60Hz)</li> </ul> </li> </ul> </li> <li>● 1x DP 1.2 <ul style="list-style-type: none"> <li>– Backward compatible with DP 1.1</li> <li>– Supports the maximum resolution of 4096×2160@60Hz or 8192×1080@60Hz.</li> <li>– HDCP 2.2 compliant</li> <li>– Custom resolutions: <ul style="list-style-type: none"> <li>Max. width: 8192 pixels (8192×1146@60Hz)</li> <li>Max. height: 4095 pixels (2188 ×095@60Hz)</li> </ul> </li> </ul> </li> </ul> <p>Status LEDs:</p> <ul style="list-style-type: none"> <li>● On: The input source is accessed normally.</li> <li>● Off: No input source is accessed or the input source is abnormal.</li> </ul>
<p>H_2xRJ45 IP input card</p>	 <p>2x RJ45 Gigabit Ethernet ports</p> <p>Support for interlaced signal input</p> <ul style="list-style-type: none"> <li>● Supported protocols: RTSP, GB28181 and ONVIF</li> <li>● Supported coding formats: H.264 and H.265</li> <li>● Single card decoding capability: <ul style="list-style-type: none"> <li>– 4x 3840×2160@30fps</li> <li>– 16x 1920×1080@30fps</li> </ul> </li> <li>● DHCP compliant</li> </ul>
<p>H_4x3G SDI input card</p>	 <p>4x 3G-SDI</p> <ul style="list-style-type: none"> <li>● Backward compatible with HD-SDI and SD-SDI</li> <li>● Supports ST-424 (3G), ST-292 (HD) and SMPTE 259 SD.</li> <li>● Each connector supports the maximum resolution of 1920×1080@60Hz.</li> <li>● Supports 1080i/576i/480i de-interlacing processing.</li> </ul> <p>Status LEDs:</p> <ul style="list-style-type: none"> <li>● On: The input source is accessed normally.</li> <li>● Off: No input source is accessed or the input source is abnormal.</li> </ul>

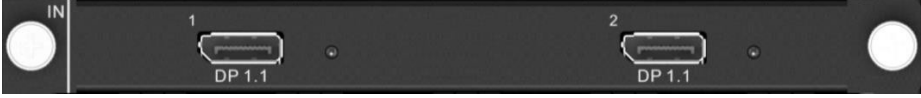
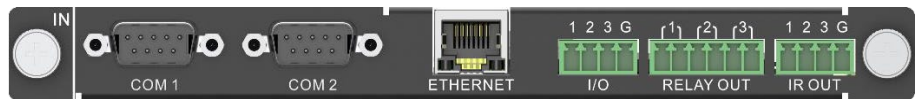
<p>H_2xCVBS+2xVGA input card</p>	 <p>2x VGA</p> <ul style="list-style-type: none"> <li>Each connector supports the maximum resolution of 1920×1080@60Hz.</li> </ul> <p>2x CVBS</p> <ul style="list-style-type: none"> <li>Supports PAL and NTSC.</li> </ul> <p>Status LEDs:</p> <ul style="list-style-type: none"> <li>On: The input source is accessed normally.</li> <li>Off: No input source is accessed or the input source is abnormal.</li> </ul>
<p>H_4xVGA input card</p>	 <p>4x VGA</p> <ul style="list-style-type: none"> <li>Each connector supports the maximum resolution of 1920×1080@60Hz.</li> </ul> <p>Status LEDs:</p> <ul style="list-style-type: none"> <li>On: The input source is accessed normally.</li> <li>Off: No input source is accessed or the input source is abnormal.</li> </ul>
<p>H_2xDP1.1 input card</p>	 <p>2x DP1.1</p> <ul style="list-style-type: none"> <li>Each connector supports the maximum resolution of 3840×1080@60Hz or 3840×2160@30Hz.</li> <li>Custom resolutions: <ul style="list-style-type: none"> <li>Max. width: 4096 pixels (4096×1124@60Hz)</li> <li>Max. height: 4095 pixels (1014×4095@60Hz)</li> </ul> </li> <li>Supports 8-bit and 10-bit inputs.</li> <li>Does not support interlaced signal input.</li> <li>HDCP 1.3 compliant</li> </ul> <p>Status LEDs:</p> <ul style="list-style-type: none"> <li>On: The input source is accessed normally.</li> <li>Off: No input source is accessed or the input source is abnormal.</li> </ul>
<p>H_STD I/O card</p>	 <ul style="list-style-type: none"> <li>2x COM Programmable RS422/RS485/RS232 ports that are used to control the devices that adopt RS422/RS485/RS232 protocol</li> <li>1x ETHERNET <ul style="list-style-type: none"> <li>Control the device that is connected to this card.</li> <li>10/100Mbps self-adaptive</li> <li>TCP/IP protocol and UDP/IP protocol supported</li> </ul> </li> <li>3x I/O <ul style="list-style-type: none"> <li>Trigger the execution of the function requirements via programming.</li> <li>Input and output modes supported</li> </ul> </li> <li>3x RELAY OUT</li> </ul>

	<ul style="list-style-type: none"> <li>- Connect to the relay to control the power on and off the connected device.</li> <li>- Voltage: 30 VDC, current: 3A at maximum</li> <li>• 3x IR OUT Programmable infrared control supported</li> </ul>
--	--

**Output Card**

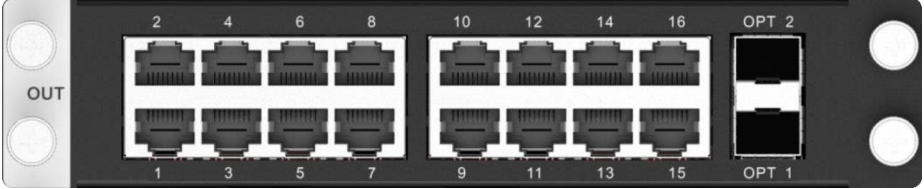
<p>H_16xRJ45+2xfiber sending card</p>	 <p>LED 4K sending card can load up to 10,400,000 pixels (max. width: 10,240 pixels, max. height: 10,240 pixels).</p> <p>This card occupies two slots.</p> <ul style="list-style-type: none"> <li>• 16x RJ45 Gigabit Ethernet outputs             <ul style="list-style-type: none"> <li>- Bit depth: 8-bit A single Ethernet port loads up to 650,000 pixels.</li> <li>- Bit depth: 10-bit A single Ethernet port loads up to 320,000 pixels.</li> <li>- Backup between Ethernet ports</li> </ul> </li> <li>• 2x OPT outputs             <ul style="list-style-type: none"> <li>- Support both SMF and MMF transmission. In SMF mode, the maximum transmission distance reaches up to 10 km.</li> <li>- OPT 1 copies and outputs the data on Ethernet ports 1–8.</li> <li>- OPT 2 copies and outputs the data on Ethernet ports 9–16.</li> </ul> </li> </ul>
---------------------------------------	---

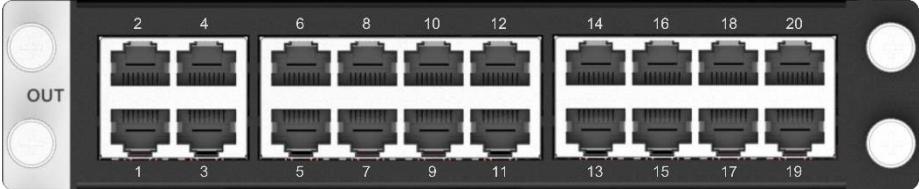
<p>H_20xRJ45 sending card</p>	 <p>LED 4K sending card can load up to 13,000,000 pixels (max. width: 10,752 pixels, max. height: 10,752 pixels).</p> <p>This card occupies two slots.</p> <ul style="list-style-type: none"> <li>• 20x RJ45 Gigabit Ethernet outputs             <ul style="list-style-type: none"> <li>- Bit depth: 8-bit A single Ethernet port loads up to 650,000 pixels.</li> <li>- Bit depth: 10-bit A single Ethernet port loads up to 320,000 pixels.</li> </ul> </li> <li>• Backup between Ethernet ports</li> </ul>
-------------------------------	--

<p>H_2xRJ45+1xHDMI1.3 preview card</p>	 <ul style="list-style-type: none"> <li>• 2x RJ45 Gigabit Ethernet outputs Connect to the network for monitoring the inputs and outputs.</li> <li>• 1x HDMI 1.3 Connect to a monitor for displaying the monitoring information.</li> </ul>
--	--



## H\_Control Card



GENLOCK	<p>Supports bi-level and tri-level.</p> <ul style="list-style-type: none"> <li>• IN: Accept the Genlock signal</li> <li>• LOOP: Loop the Genlock signal.</li> </ul>
ETHERNET	<p>A Gigabit Ethernet port</p> <ul style="list-style-type: none"> <li>• Connect to the control PC for communication.</li> <li>• Connect to the router, switch or PC.</li> <li>• For Web control and NovalCT screen configuration</li> </ul>
USB 1 & USB 2	<p>2x USB 2.0</p> <ul style="list-style-type: none"> <li>• Update the device program.</li> <li>• Import or export the device configuration parameters.</li> </ul>
COM	<p>A serial port that adopts RS232 serial protocol Support for central control system</p> <ul style="list-style-type: none"> <li>• IN: Accept the signal from the central control system.</li> <li>• OUT: Loop the signal.</li> </ul>
Power switch	<ul style="list-style-type: none"> <li>• – / <b>ON</b>: Power on the device.</li> <li>• <b>O</b> / <b>OFF</b>: Power off the device.</li> </ul>

## Applications

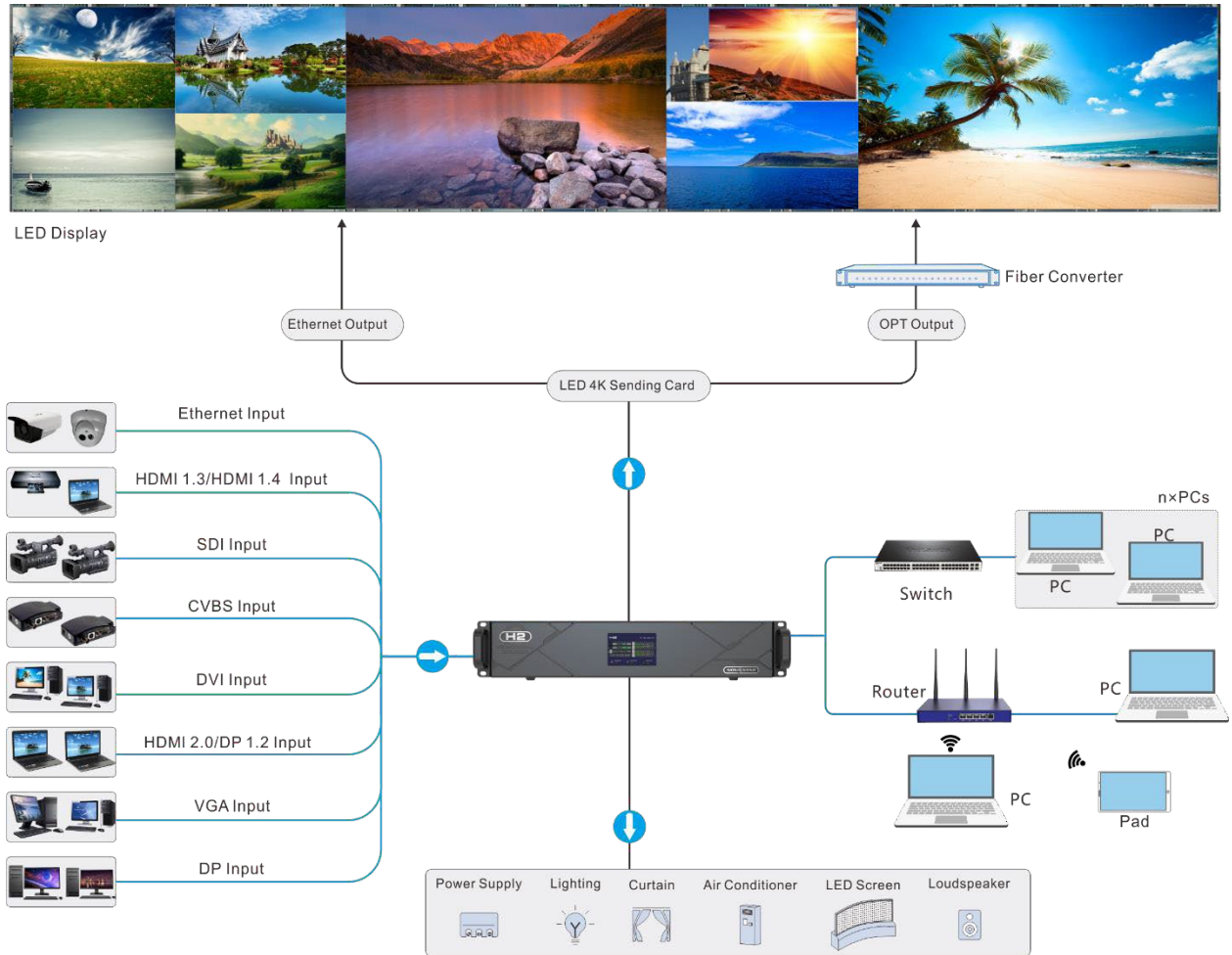

## Dimensions

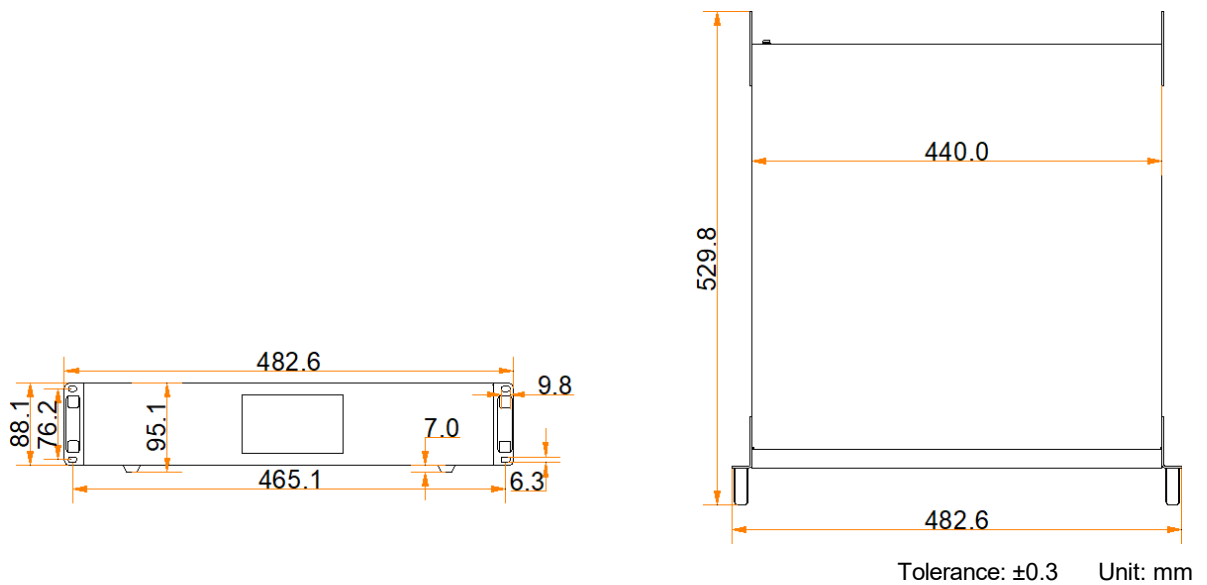

## Specifications

<b>Model</b>		H2
<b>Rack Unit</b>		2U
<b>Max. Input Cards</b>		4
<b>Max. Input Channels</b>		16
<b>Max. Output Cards</b>		2
<b>Max. Loading Capacity (LED 4K sending card)</b>		26,000,000 pixels
<b>Max. Layers</b>		32
<b>Electrical Specifications</b>	<b>Power connector</b>	100–240V~, 50/60Hz, 10A–5A
	<b>Power consumption</b>	210 W
<b>Operating Environment</b>	<b>Temperature</b>	0°C to 45°C
	<b>Humidity</b>	0% to 80%, non-condensing
<b>Storage Environment</b>	<b>Temperature</b>	–10°C to +60°C
	<b>Humidity</b>	0% to 95%, non-condensing
<b>Physical Specifications</b>	<b>Dimensions</b>	482.6 mm × 88.1 mm × 455 mm
	<b>Net weight</b>	15.6 kg
	<b>Gross weight</b>	18 kg
<b>Packing Information</b>	<b>Packing box</b>	660 mm × 570 mm × 210 mm
	<b>Accessories</b>	1x Power cord 1x RJ45 Ethernet cable 1x Grounding cable 1x HDMI cable 1x Quick Start Guide 1x Certificate of Approval 1x Safety Manual 1x Custom Letter
<b>Certifications</b>		RoHS, EAC

## Video Source Features

Input Connector	Color Depth		Max. Input Resolution
HDMI 2.0	8-bit	RGB 4:4:4	4096×2160@60Hz
		YCbCr 4:4:4	8192×1080@60Hz
		YCbCr 4:2:2	
		YCbCr 4:2:0	4096×2160@60Hz
	10-bit	RGB 4:4:4	4096×2160@30Hz
		YCbCr 4:4:4	4096×1080@60Hz
		YCbCr 4:2:2	4096×2160@60Hz
		YCbCr 4:2:0	
	12-bit	RGB 4:4:4	4096×2160@30Hz
		YCbCr 4:4:4	4096×1080@60Hz
		YCbCr 4:2:2	4096×2160@60Hz
		YCbCr 4:2:0	
DP 1.2	8-bit	RGB 4:4:4	4096×2160@60Hz
		YCbCr 4:4:4	8192×1080@60Hz
		YCbCr 4:2:2	
		YCbCr 4:2:0	Not supported
	10-bit	RGB 4:4:4	4096×2160@30Hz
		YCbCr 4:4:4	4096×1080@60Hz
		YCbCr 4:2:2	4096×2160@60Hz
		YCbCr 4:2:0	Not supported
	12-bit	RGB 4:4:4	4096×2160@30Hz
		YCbCr 4:4:4	4096×1080@60Hz
		YCbCr 4:2:2	4096×2160@60Hz
		YCbCr 4:2:0	Not supported
HDMI 1.4a DP 1.1	8-bit	RGB 4:4:4	4096×1080@60Hz
		YCbCr 4:4:4	
		YCbCr 4:2:2	
		YCbCr 4:2:0	Not supported
	10-bit	RGB 4:4:4	2048×1152@60Hz

Input Connector	Color Depth		Max. Input Resolution	
		YCbCr 4:4:4		
		YCbCr 4:2:2	4096×1080@60Hz	
		YCbCr 4:2:0	Not supported	
	12-bit	RGB 4:4:4	2048×1152@60Hz	
		YCbCr 4:4:4		
		YCbCr 4:2:2	4096×1080@60Hz	
		YCbCr 4:2:0	Not supported	
	HDMI 1.3	8-bit	RGB 4:4:4	2048×1152@60Hz
YCbCr 4:4:4				
YCbCr 4:2:2				
YCbCr 4:2:0			Not supported	
10-bit		RGB 4:4:4	2048×1152@60Hz	
		YCbCr 4:4:4		
		YCbCr 4:2:2		
		YCbCr 4:2:0	Not supported	
12-bit		RGB 4:4:4	2048×1152@60Hz	
		YCbCr 4:4:4		
		YCbCr 4:2:2		
		YCbCr 4:2:0	Not supported	
SL-DVI		8-bit	RGB 4:4:4	2048×1152@60Hz
DL-DVI		8-bit	RGB 4:4:4	3840×1080@60Hz
VGA CVBS		-	RGB 4:4:4	1920×1080@60Hz
3G-SDI		<ul style="list-style-type: none"> <li>• Supports up to 1920×1080@60Hz video inputs.</li> <li>• Input resolution and bit depth settings are not allowed.</li> <li>• Supports ST-424 (3G) and ST-292 (HD).</li> </ul>		

**Official Website**  
[www.ovidion.com](http://www.ovidion.com)

**Technical Support**  
support@ovidion.com

